

Features

- High breakdown voltage to 650V for improved reliability
- Trench-stop technology offering:
 - High speed switching
 - High ruggedness, temperature stable behavior
 - Short circuit withstand time: 5μs
 - Low $V_{CE(SAT)}$
 - Easy parallel switching capability due to positive temperature coefficient in $V_{CE(SAT)}$
- Enhanced avalanche capability

HF

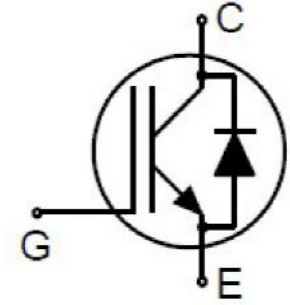

Applications

- Uninterruptible power supplies
- Solar inverter

Mechanical Data

- Case: TO-247
- Molding Compound: UL Flammability Classification Rating 94V-0
- Terminals: Matte tin-plated leads; solderability-per MIL-STD-202, Method 208

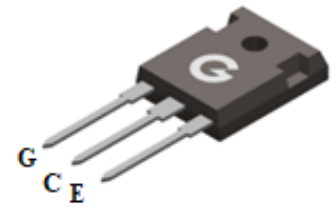

TO-247

Ordering Information

Part Number	Package	Shipping Quantity	Marking Code
GKU75N65DH5	TO-247	30 pcs / Tube	KU75N65DH5

Maximum Ratings (@ $T_C = 25^\circ\text{C}$ unless otherwise specified)

Parameter	Symbol	Value	Unit
Collector-to-Emitter Voltage	V_{CES}	650	V
Gate-Emitter Voltage	V_{GES}	± 20	V
DC Collector Current ($T_C = 25^\circ\text{C}$, limited by maximum T_J)	I_C	150	A
DC Collector Current ($T_C = 100^\circ\text{C}$, limited by maximum T_J)		75	A
Diode Continuous Forward Current ($T_C = 25^\circ\text{C}$, limited by maximum T_J)	I_F	80	A
Diode Continuous Forward Current ($T_C = 100^\circ\text{C}$, limited by maximum T_J)		40	A
Pulsed Collector Current (Pulse width limited by maximum T_J , $V_{GE} = 15\text{V}$)	I_{CM}	225	A
Short Circuit Withstand Time ($V_{GE} = 15\text{V}$, $V_{CE} \leq 400\text{V}$)	T_{SC}	5	μs
Soldering Temperature, Wave Soldering 1.6mm (0.063in.) from case for 10s	T_{sold}	260	$^\circ\text{C}$
Power Dissipation ($T_C = 25^\circ\text{C}$)	P_D	375	W
Operating Junction Temperature Range	T_J	-55 ~ +175	$^\circ\text{C}$
Storage Temperature Range	T_{STG}	-55 ~ +175	$^\circ\text{C}$

Thermal Characteristics

Parameter	Symbol	Min.	Typ.	Max.	Unit
Thermal Resistance Junction-to-Case, IGBT	R _{θJC}	-	0.27	0.4	°C/W
Thermal Resistance Junction-to-Case, Diode		-	0.72	1.1	°C/W
Thermal Resistance Junction-to-Air	R _{θJA}	-	-	40	°C/W

Electrical Characteristics of the IGBT (@ T_J = 25°C unless otherwise specified)

Symbol	Parameter	Test Condition	Min.	Typ.	Max.	Unit
Static Characteristics						
V _{(BR)CES}	Collector-Emitter Breakdown Voltage	V _{GE} = 0V, I _C = 250μA	650	-	-	V
I _{CES}	Collector-Emitter Leakage Current	V _{CE} = 650V, V _{GE} = 0V, T _J = 25°C	-	-	100	μA
		V _{CE} = 650V, V _{GE} = 0V, T _J = 175°C	-	-	5	mA
I _{GES}	Gate to Emitter Leakage Current	V _{GE} = ±20V, V _{CE} = 0V	-	-	±200	nA
V _{CE(sat)}	Collector-Emitter Saturation Voltage	V _{GE} = 15V, I _C = 75A, T _J = 25°C	-	1.7	2.1	V
		V _{GE} = 15V, I _C = 75A, T _J = 175°C	-	2.3	-	V
V _{GE(th)}	Gate Threshold Voltage	V _{CE} = V _{GE} , I _C = 250μA	4.2	5.4	6.2	V
g _{fs}	Transconductance	V _{CE} = 20V, I _C = 75A	-	40	-	S
R _G	Gate Resistance	V _{GE} = 0V, f = 1MHz	-	1.97	-	Ω
Dynamic Characteristics						
Q _G	Total Gate-Charge	V _{CC} = 520V, V _{GE} = 15V, I _C = 75A	-	142	-	nC
C _{ies}	Input Capacitance	V _{CE} = 25V V _{GE} = 0V f = 100kHz	-	4753	-	pF
C _{oes}	Output Capacitance		-	184	-	
C _{res}	Reverse Transfer Capacitance		-	31	-	
I _{C(SC)}	Short Circuit Collector Current	V _{GE} = 15V, t _{SC} ≤ 5μs V _{CC} = 400V, T _J = 25°C	-	500	-	A
Switching Characteristics						
t _{d(on)}	Turn-on Delay Time	V _{CE} = 400V V _{GE} = 15V I _C = 75A R _G = 20Ω T _J = 25°C	-	89	-	ns
t _r	Turn-on Rise Time		-	144	-	
t _{d(off)}	Turn-Off Delay Time		-	244	-	
t _f	Turn-Off Fall Time		-	99	-	
E _{on}	Turn-On Switching Loss		-	3.81	-	mJ
E _{off}	Turn-Off Switching Loss	-	2.02	-		

Electrical Characteristics of the Diode (@ $T_J = 25^\circ\text{C}$ unless otherwise specified)

Symbol	Parameter	Test Condition	Min.	Typ.	Max.	Unit
Dynamic Characteristics						
V_{FM}	Diode Forward Voltage	$I_F = 40\text{A}, V_{GE} = 0\text{V}$	-	1.8	-	V
t_{rr}	Reverse recovery time	$V_{GS} = 0\text{V}, I_F = 40\text{A}$ $di/dt = 300\text{A}/\mu\text{s}$	-	97	-	ns
Q_{rr}	Reverse recovery charge		-	428	-	nC
I_{rrm}	Peak Reverse Recovery Current		-	8.3	-	A

Ratings and Characteristics Curves (@ $T_A = 25^\circ\text{C}$ unless otherwise specified)

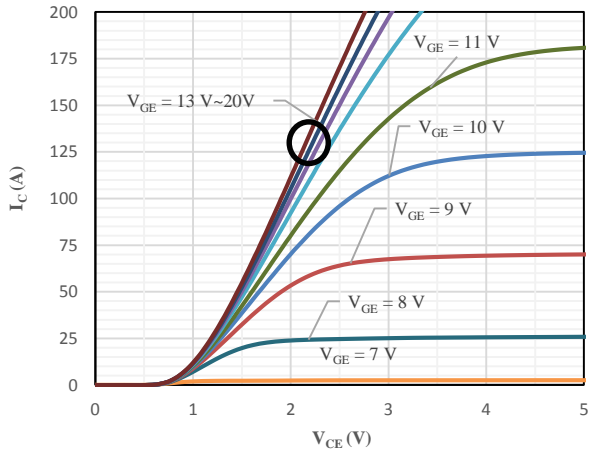

Fig 1 Typical Output Characteristics

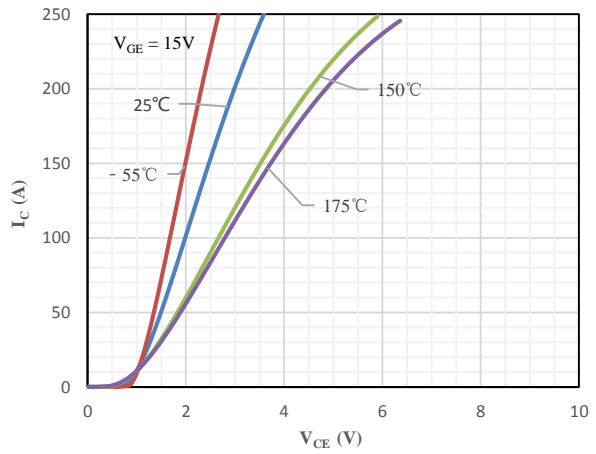

Fig 2 Saturation Voltage Characteristics

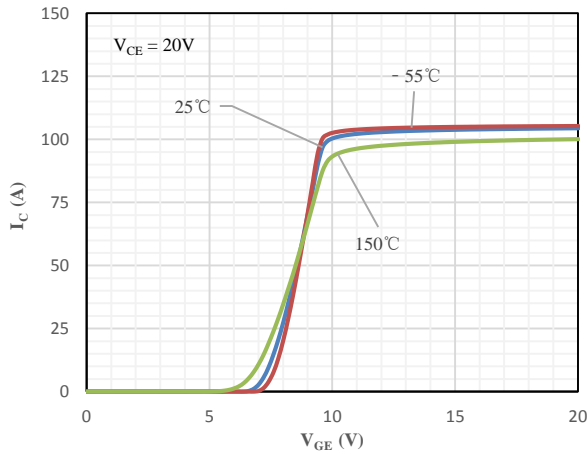

Fig 3 Transfer Characteristics

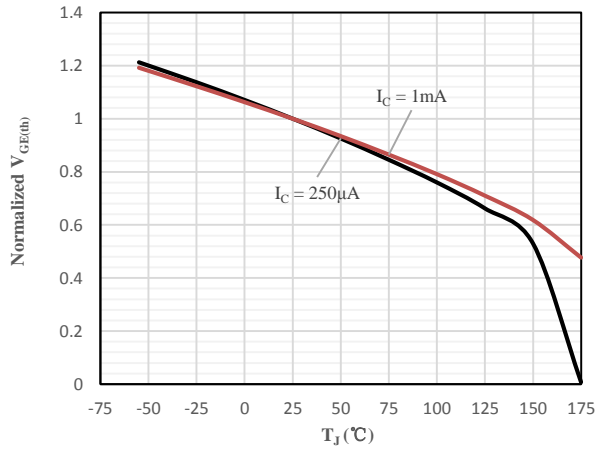

Fig 4 Normalized $V_{GE(th)}$ vs. Junction Temperature

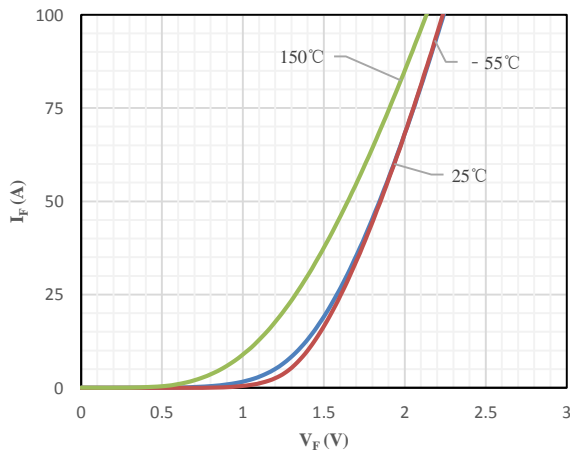

Fig 5 Body-Diode Characteristics

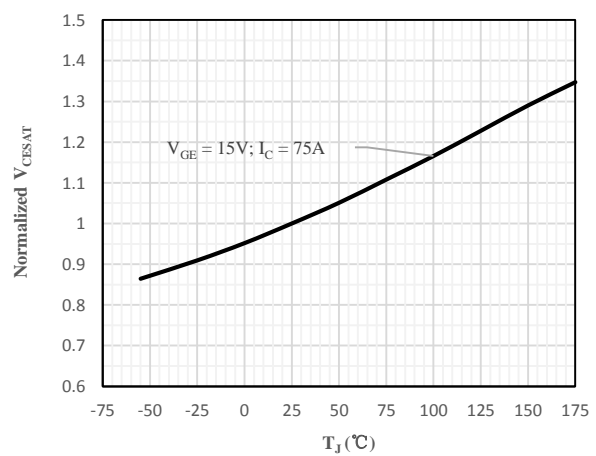

Fig 6 Normalized Collector-Emitter Saturation Voltage vs. Junction Temperature

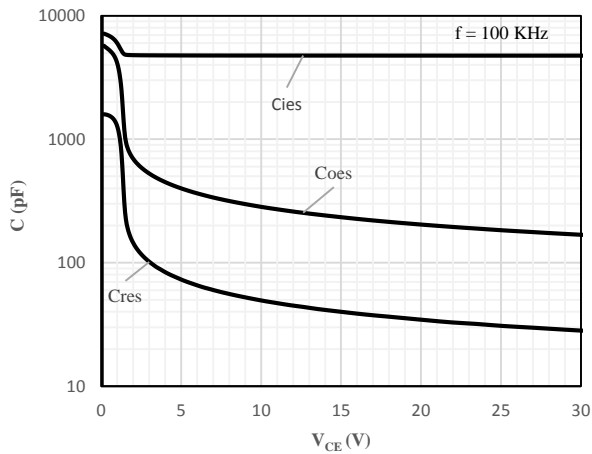

Fig 7 Capacitance Characteristics

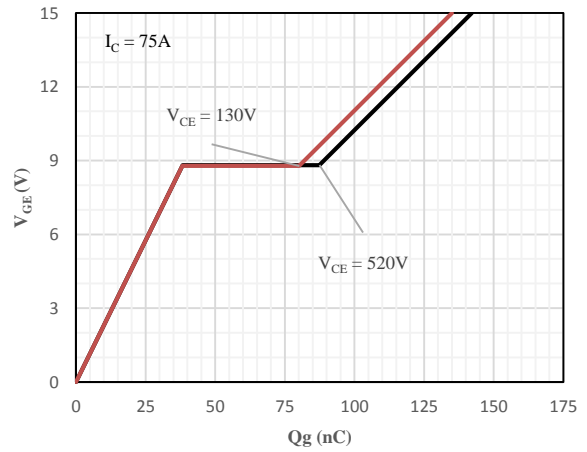

Fig 8 Gate-Charge Characteristics

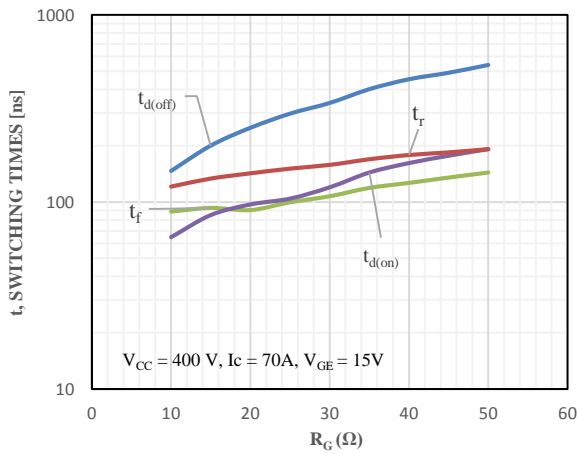

Fig 9 Switching Times vs. Gate Resistor

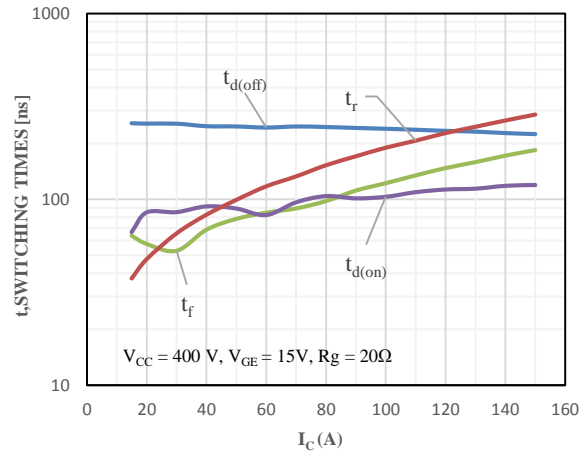

Fig 10 Switching Times vs. Collector Current

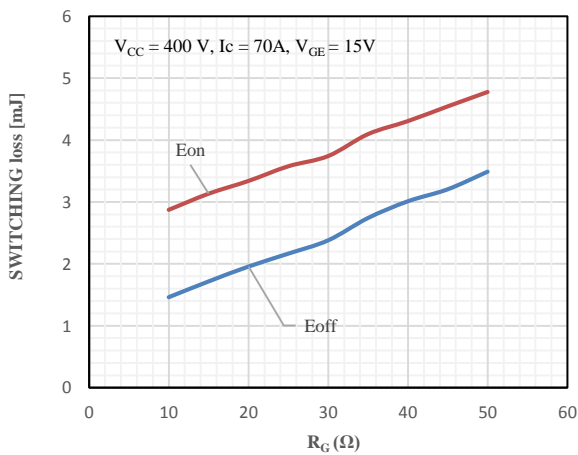

Fig 11 Switching Loss vs. Gate Resistor

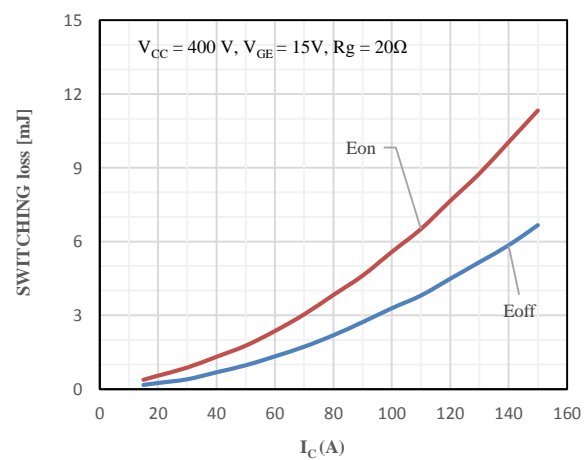

Fig 12 Switching Loss vs. Collector Current

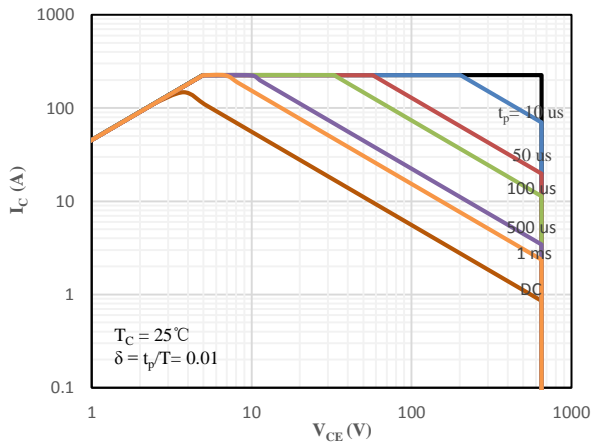

Fig 13 SOA characteristics

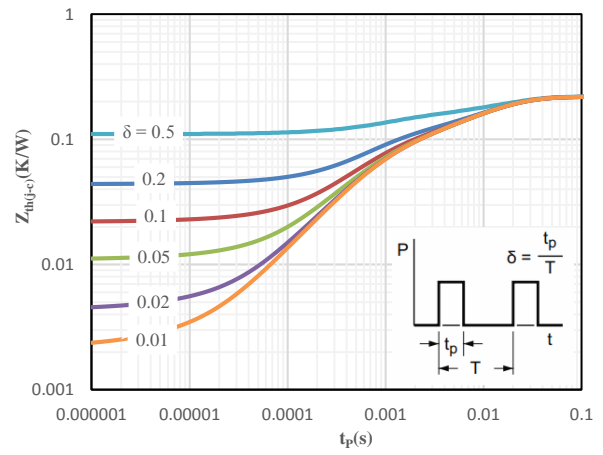
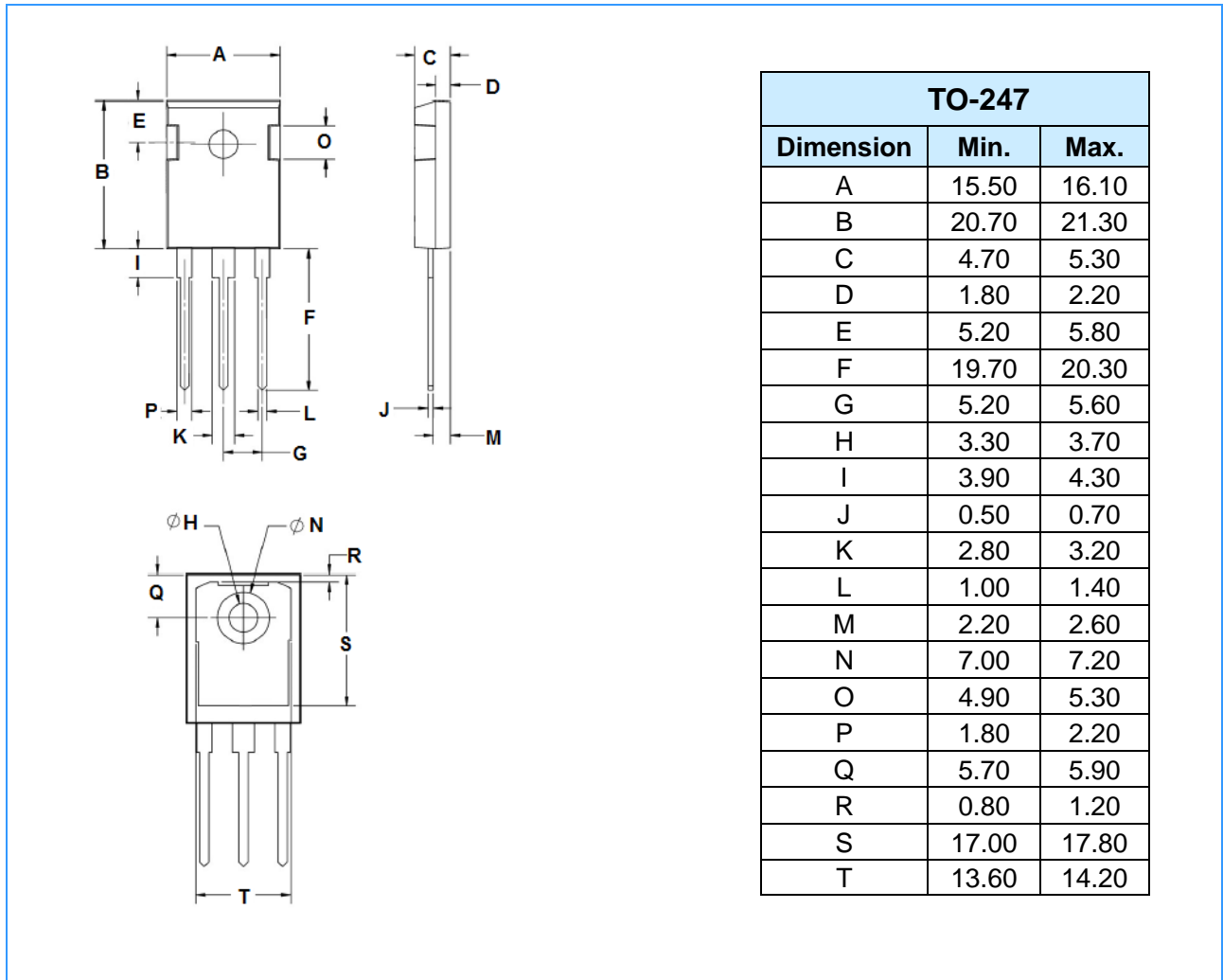

Fig 14 Maximum transient thermal impedance

Package Outline Dimensions (Unit: mm)



IMPORTANT NOTICE

Changzhou Galaxy Century Microelectronics (GME) reserves the right to make changes without further notice to any product information (copyrighted) herein to make corrections, modifications, improvements, or other changes. GME does not assume any liability arising out of the application or use of any product described herein; neither does it convey any license under its patent rights, nor the rights of others.