



# SGM8552

## Single-Supply, Dual Rail-to-Rail I/O Precision Operational Amplifier

---

### GENERAL DESCRIPTION

The SGM8552 is a dual, precision operational amplifier which can operate from 2.5V to 5.5V single supply. The device provides rail-to-rail input and output operation.

The SGM8552 offers a low offset voltage less than 20 $\mu$ V and an ultra-low bias current of 10pA. The combination of characteristics makes the SGM8552 a good choice for temperature measurements, pressure and position sensors, strain gauge amplifiers and medical instrumentation, or any other 2.5V to 5.5V applications requiring precision and long-term stability.

The SGM8552 is available in Green SOIC-8 and MSOP-8 packages and ESD (HBM) reaches 8kV. It is specified over the extended industrial temperature range (-40°C to +125°C).

### FEATURES

- **Low Offset Voltage: 20 $\mu$ V (MAX)**
- **Ultra-Low Input Bias Current: 10pA**
- **Large-Signal Voltage Gain: 145dB (TYP) at 5V**
- **PSRR: 110dB (TYP)**
- **CMRR: 105dB (TYP)**
- **Overload Recovery Time: 60 $\mu$ s (at  $V_S = 5V$ )**
- **Rail-to-Rail Input and Output**
- **Supply Voltage Range: 2.5V to 5.5V**
- **Low Supply Current: 930 $\mu$ A (TYP)**
- **No External Capacitors Required**
- **-40°C to +125°C Operating Temperature Range**
- **Available in Green SOIC-8 and MSOP-8 Packages**

### APPLICATIONS

Pressure Sensors  
Temperature Measurements  
Precision Current Sensing  
Electronic Scales  
Strain Gauge Amplifiers  
Handheld Test Equipment  
Thermocouple Amplifiers  
Medical Instrumentation

**PACKAGE/ORDERING INFORMATION**

MODEL	PACKAGE DESCRIPTION	SPECIFIED TEMPERATURE RANGE	ORDERING NUMBER	PACKAGE MARKING	PACKING OPTION
SGM8552	SOIC-8	-40°C to +125°C	SGM8552XS8G/TR	SGM8552XS8 XXXXX	Tape and Reel, 2500
	MSOP-8	-40°C to +125°C	SGM8552XMS8G/TR	SGM8552 XMS8 XXXXX	Tape and Reel, 3000

**MARKING INFORMATION**

NOTE: XXXXX = Date Code and Vendor Code.

**XXXXX**

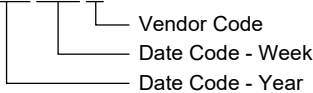

Green (RoHS & HSF): SG Micro Corp defines "Green" to mean Pb-Free (RoHS compatible) and free of halogen substances. If you have additional comments or questions, please contact your SGMICRO representative directly.

**ABSOLUTE MAXIMUM RATINGS**

Supply Voltage.....	6V
Input Voltage Range.....	(-V <sub>S</sub> ) - 0.3V to (+V <sub>S</sub> ) + 0.3V
Differential Input Voltage Range.....	-5V to 5V
Junction Temperature.....	+150°C
Storage Temperature Range.....	-65°C to +150°C
Lead Temperature (Soldering, 10s).....	+260°C
ESD Susceptibility	
HBM.....	8000V
MM.....	400V

**RECOMMENDED OPERATING CONDITIONS**

Operating Temperature Range.....	-40°C to +125°C
----------------------------------	-----------------

**OVERSTRESS CAUTION**

Stresses beyond those listed in Absolute Maximum Ratings may cause permanent damage to the device. Exposure to absolute maximum rating conditions for extended periods may affect reliability. Functional operation of the device at any conditions beyond those indicated in the Recommended Operating Conditions section is not implied.

**ESD SENSITIVITY CAUTION**

This integrated circuit can be damaged if ESD protections are not considered carefully. SGMICRO recommends that all integrated circuits be handled with appropriate precautions. Failure to observe proper handling and installation procedures

can cause damage. ESD damage can range from subtle performance degradation to complete device failure. Precision integrated circuits may be more susceptible to damage because even small parametric changes could cause the device not to meet the published specifications.

**DISCLAIMER**

SG Micro Corp reserves the right to make any change in circuit design, or specifications without prior notice.

**PIN CONFIGURATION**

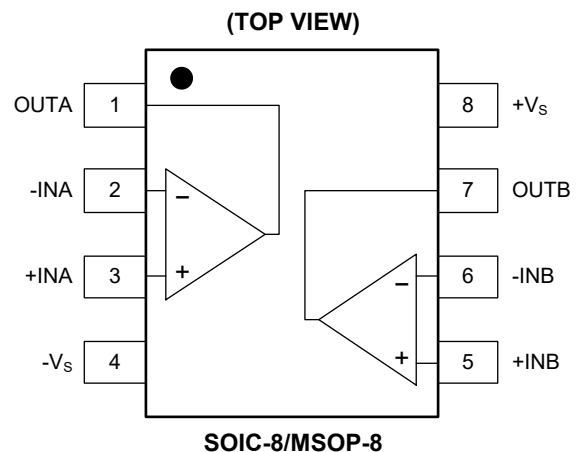

## ELECTRICAL CHARACTERISTICS

(V<sub>S</sub> = 5V, V<sub>CM</sub> = 2.5V, V<sub>OUT</sub> = 2.5V, Full = -40°C to +125°C, typical values are at T<sub>A</sub> = +25°C, unless otherwise noted.)

PARAMETER	CONDITIONS	TEMP	MIN	TYP	MAX	UNITS
<b>Input Characteristics</b>						
Input Offset Voltage (V <sub>OS</sub> )		+25°C		4	20	μV
		Full			24	
Input Bias Current (I <sub>b</sub> )		+25°C		10		pA
Input Offset Current (I <sub>OS</sub> )		+25°C		5		pA
Input Voltage Range		+25°C	0		5	V
Common Mode Rejection Ratio <sup>(1)</sup> (CMRR)	V <sub>CM</sub> = 0V to 5V	+25°C	90	105		dB
		Full	83			
Large-Signal Voltage Gain (A <sub>VO</sub> )	R <sub>L</sub> = 10kΩ, V <sub>OUT</sub> = 0.3V to 4.7V	+25°C	100	145		dB
		Full	97			
Input Offset Voltage Drift (ΔV <sub>OS</sub> /ΔT)		Full		20		nV/°C
<b>Output Characteristics</b>						
Output Voltage High (V <sub>OH</sub> )	R <sub>L</sub> = 100kΩ to -V <sub>S</sub>	+25°C	4.99	4.998		V
		Full	4.987			
	R <sub>L</sub> = 10kΩ to -V <sub>S</sub>	+25°C	4.985	4.996		
		Full	4.98			
Output Voltage Low (V <sub>OL</sub> )	R <sub>L</sub> = 100kΩ to +V <sub>S</sub>	+25°C		2	10	mV
		Full			13	
	R <sub>L</sub> = 10kΩ to +V <sub>S</sub>	+25°C		6	15	
		Full			20	
Short-Circuit Limit (I <sub>SC</sub> )	V <sub>OUT</sub> = 2.5V, R <sub>L</sub> = 10Ω to GND	+25°C	40	48		mA
		Full	23			
<b>Power Supply</b>						
Power Supply Rejection Ratio <sup>(1)</sup> (PSRR)	V <sub>S</sub> = 2.5V to 5.5V	+25°C	90	110		dB
		Full	80			
Quiescent Current (I <sub>Q</sub> )	V <sub>OUT</sub> = V <sub>S</sub> /2	+25°C		930	1110	μA
		Full			1760	
<b>Dynamic Performance</b>						
Gain-Bandwidth Product (GBP)	A <sub>V</sub> = +100	+25°C		1.53		MHz
Slew Rate (SR)	A <sub>V</sub> = +1, R <sub>L</sub> = 10kΩ, 2V output step	+25°C		0.90		V/μs
Overload Recovery Time	A <sub>V</sub> = -100, R <sub>L</sub> = 10kΩ, V <sub>IN</sub> = 200mV (RET to GND)	+25°C		0.06		ms
<b>Noise Performance</b>						
Input Voltage Noise (e <sub>n P-P</sub> )	0.1Hz to 10Hz	+25°C		0.80		μV <sub>P-P</sub>
Input Voltage Noise Density (e <sub>n</sub> )	f = 1kHz	+25°C		47.5		nV/√Hz
Input Current Noise Density (I <sub>n</sub> )	f = 1kHz	+25°C		130		fA/√Hz

NOTE: 1. PSRR and CMRR are affected by the matching between external gain-setting resistor ratios.

**ELECTRICAL CHARACTERISTICS (continued)**(V<sub>S</sub> = 2.5V, V<sub>CM</sub> = 1.25V, V<sub>OUT</sub> = 1.25V, Full = -40°C to +125°C, typical values are at T<sub>A</sub> = +25°C, unless otherwise noted.)

PARAMETER	CONDITIONS	TEMP	MIN	TYP	MAX	UNITS
<b>Input Characteristics</b>						
Input Offset Voltage (V <sub>OS</sub> )		+25°C		3	20	μV
		Full			24	
Input Bias Current (I <sub>b</sub> )		+25°C		10		pA
Input Offset Current (I <sub>OS</sub> )		+25°C		10		pA
Input Voltage Range		+25°C	0		2.5	V
Common Mode Rejection Ratio <sup>(1)</sup> (CMRR)	V <sub>CM</sub> = 0V to 2.5V	+25°C	90	105		dB
		Full	81			
Large-Signal Voltage Gain (A <sub>VO</sub> )	R <sub>L</sub> = 10kΩ, V <sub>OUT</sub> = 0.3V to 2.4V	+25°C	100	135		dB
		Full	94			
Input Offset Voltage Drift (ΔV <sub>OS</sub> /ΔT)		Full		20		nV/°C
<b>Output Characteristics</b>						
Output Voltage High (V <sub>OH</sub> )	R <sub>L</sub> = 100kΩ to -V <sub>S</sub>	+25°C	2.49	2.499		V
		Full	2.488			
	R <sub>L</sub> = 10kΩ to -V <sub>S</sub>	+25°C	2.485	2.498		
		Full	2.482			
Output Voltage Low (V <sub>OL</sub> )	R <sub>L</sub> = 100kΩ to +V <sub>S</sub>	+25°C		1	10	mV
		Full			12	
	R <sub>L</sub> = 10kΩ to +V <sub>S</sub>	+25°C		3	15	
		Full			18	
Short-Circuit Limit (I <sub>SC</sub> )	V <sub>OUT</sub> = 1.25V, R <sub>L</sub> = 10Ω to GND	+25°C	20	28		mA
		Full	15			
<b>Power Supply</b>						
Power Supply Rejection Ratio <sup>(1)</sup> (PSRR)	V <sub>S</sub> = 2.5V to 5.5V	+25°C	90	110		dB
		Full	80			
Quiescent Current (I <sub>Q</sub> )	V <sub>OUT</sub> = V <sub>S</sub> /2	+25°C		1000	1110	μA
		Full			2090	
<b>Dynamic Performance</b>						
Gain-Bandwidth Product (GBP)	A <sub>V</sub> = +100	+25°C		1.51		MHz
Slew Rate (SR)	A <sub>V</sub> = +1, R <sub>L</sub> = 10kΩ, 2V output step	+25°C		0.90		V/μs
Overload Recovery Time	A <sub>V</sub> = -100, R <sub>L</sub> = 10kΩ, V <sub>IN</sub> = 200mV (RET to GND)	+25°C		0.03		ms
<b>Noise Performance</b>						
Input Voltage Noise (e <sub>n P-P</sub> )	0.1Hz to 10Hz	+25°C		0.95		μV <sub>P-P</sub>
Input Voltage Noise Density (e <sub>n</sub> )	f = 1kHz	+25°C		53		nV/√Hz
Input Current Noise Density (I <sub>n</sub> )	f = 1kHz	+25°C		160		fA/√Hz

NOTE: 1. PSRR and CMRR are affected by the matching between external gain-setting resistor ratios.

TYPICAL PERFORMANCE CHARACTERISTICS

At  $T_A = +25^\circ\text{C}$ , unless otherwise noted.

Large-Signal Transient Response

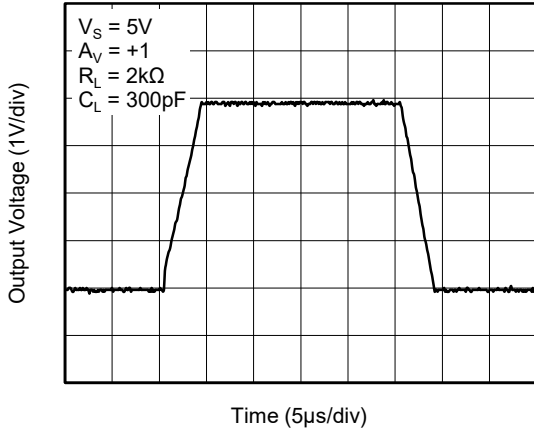

Large-Signal Transient Response

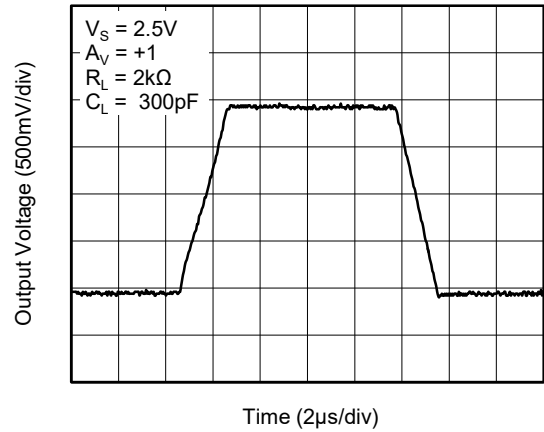

Small-Signal Transient Response

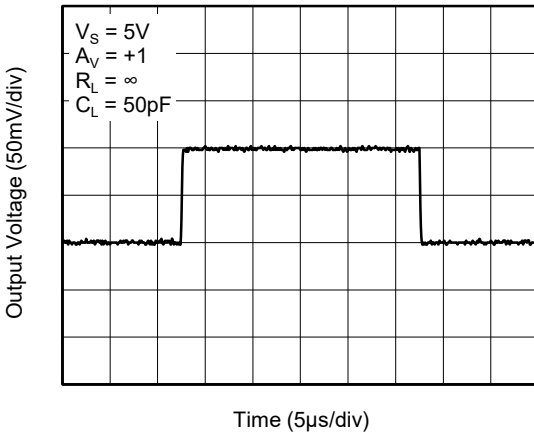

Small-Signal Transient Response

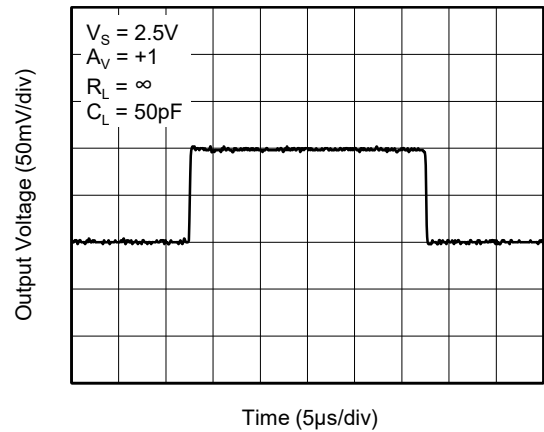

Closed-Loop Gain vs. Frequency

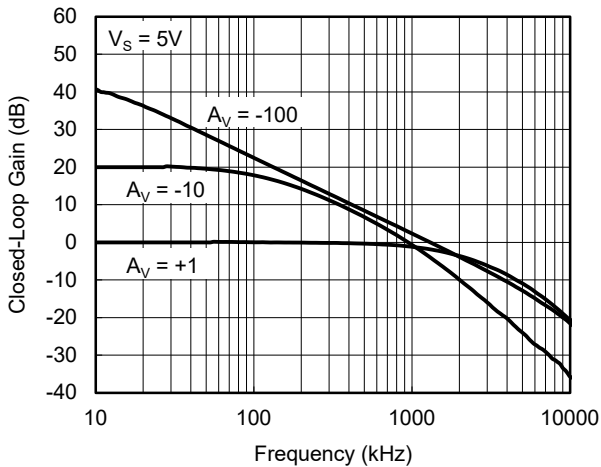

Closed-Loop Gain vs. Frequency

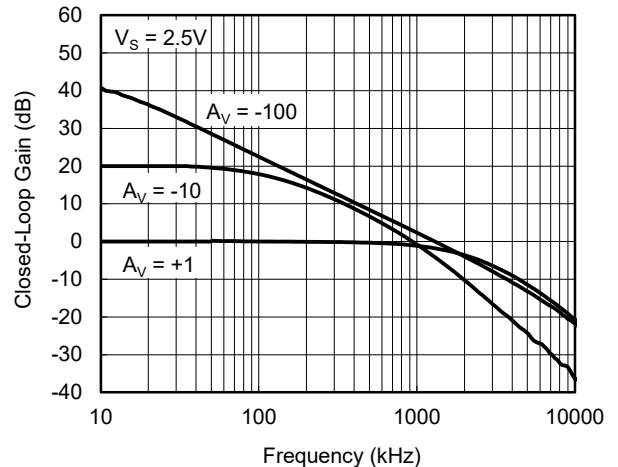

TYPICAL PERFORMANCE CHARACTERISTICS (continued)

At  $T_A = +25^\circ\text{C}$ , unless otherwise noted.

Positive Over-Voltage Recovery

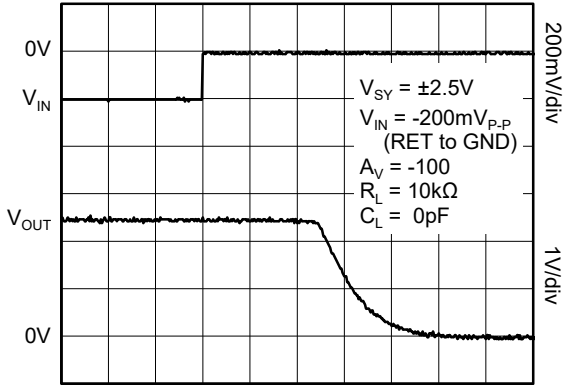

Time (20 $\mu$ s/div)

Negative Over-Voltage Recovery

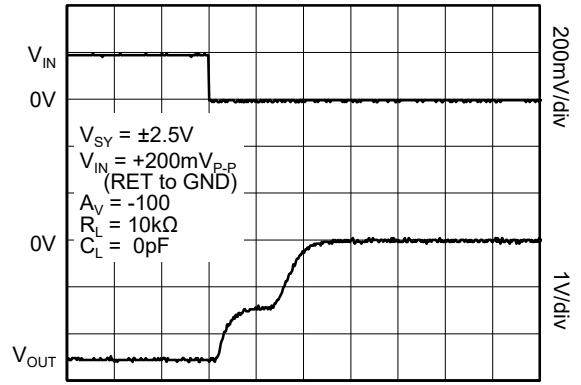

Time (50 $\mu$ s/div)

Open-Loop Gain and Phase vs. Frequency

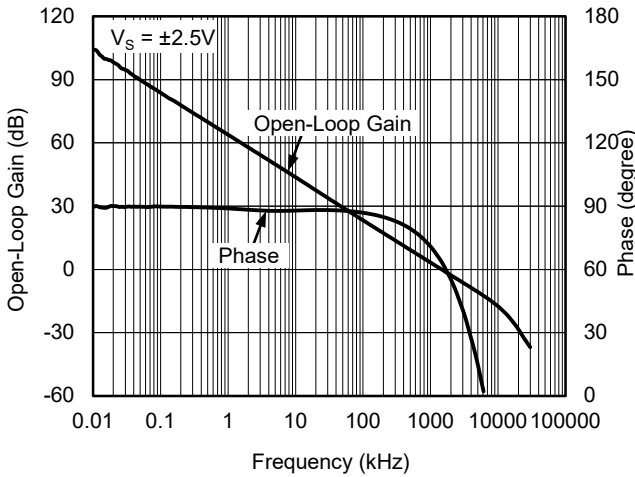

Frequency (kHz)

Open-Loop Gain and Phase vs. Frequency

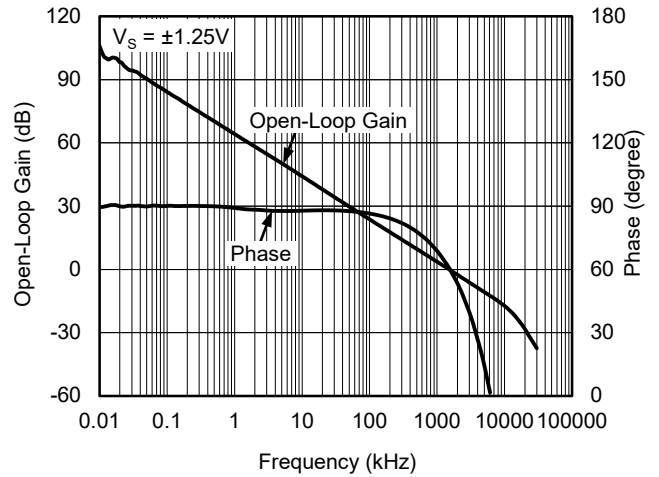

Frequency (kHz)

0.1Hz to 10Hz Noise

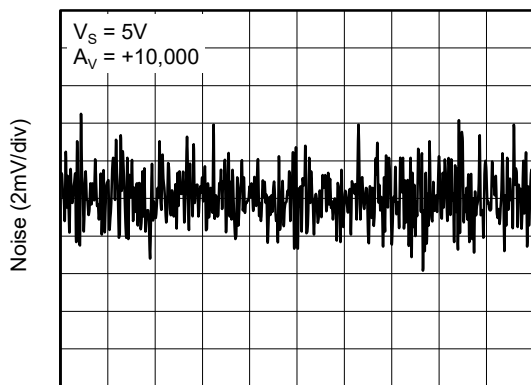

Time (10s/div)

0.1Hz to 10Hz Noise

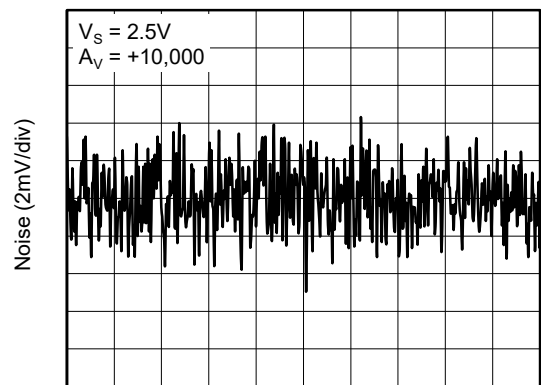

Time (10s/div)

TYPICAL PERFORMANCE CHARACTERISTICS (continued)

At  $T_A = +25^\circ\text{C}$ , unless otherwise noted.

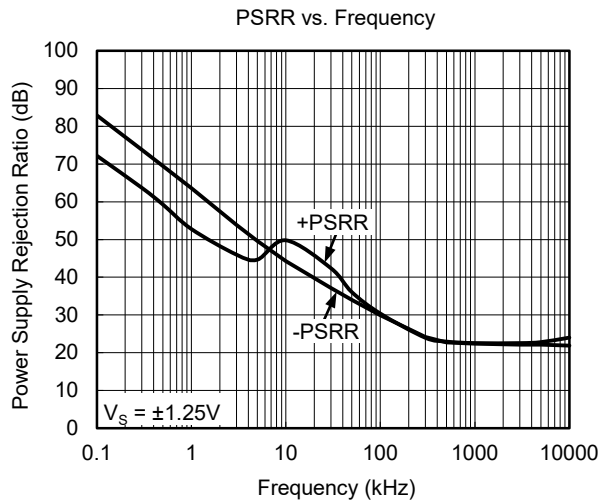
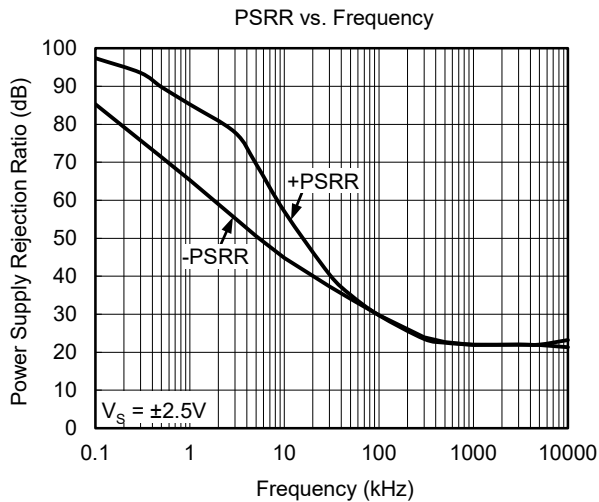
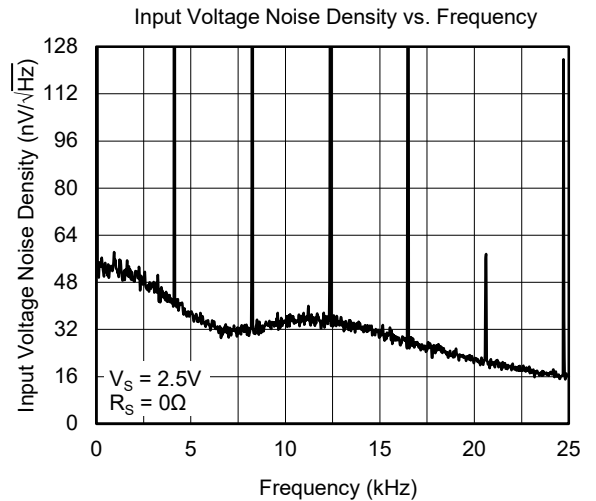
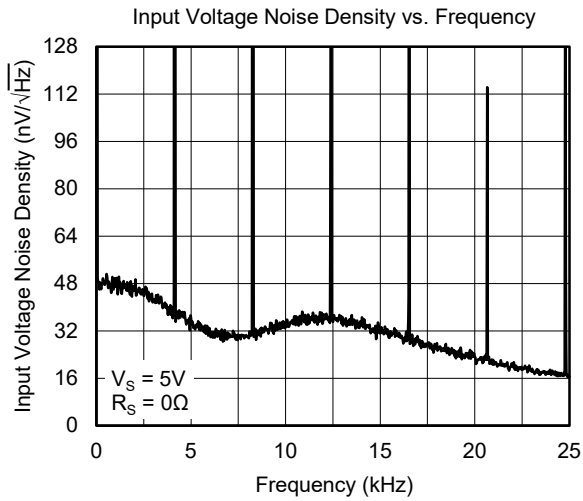
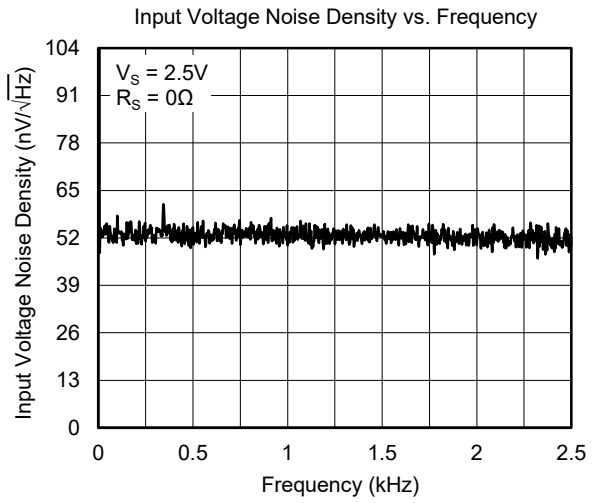
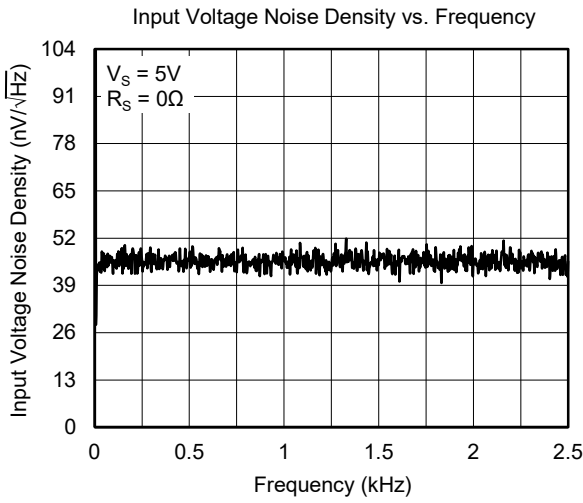

TYPICAL PERFORMANCE CHARACTERISTICS (continued)

At  $T_A = +25^\circ\text{C}$ , unless otherwise noted.

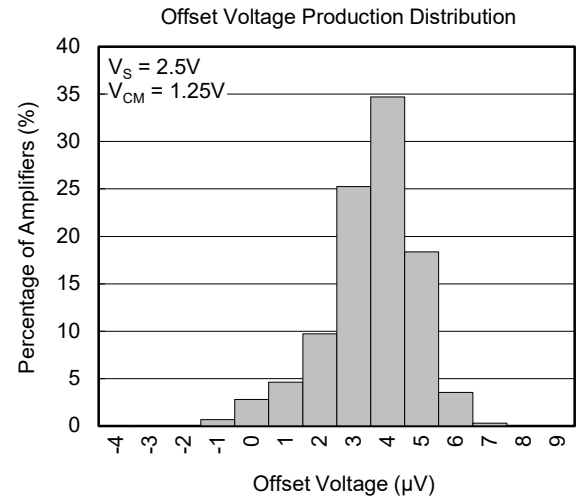
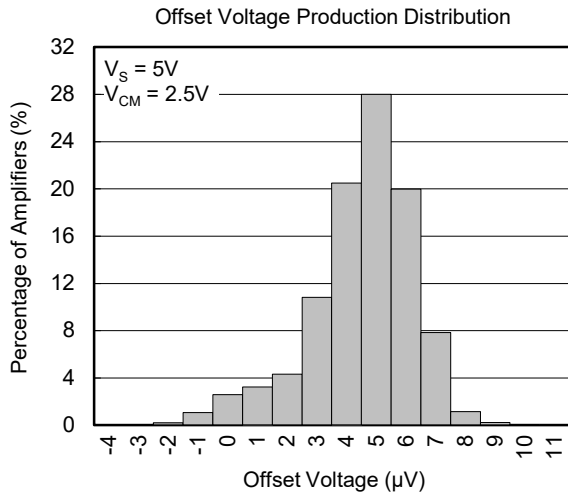
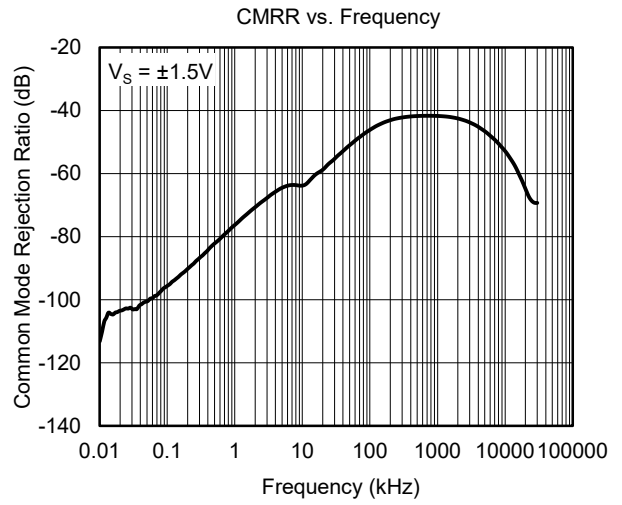
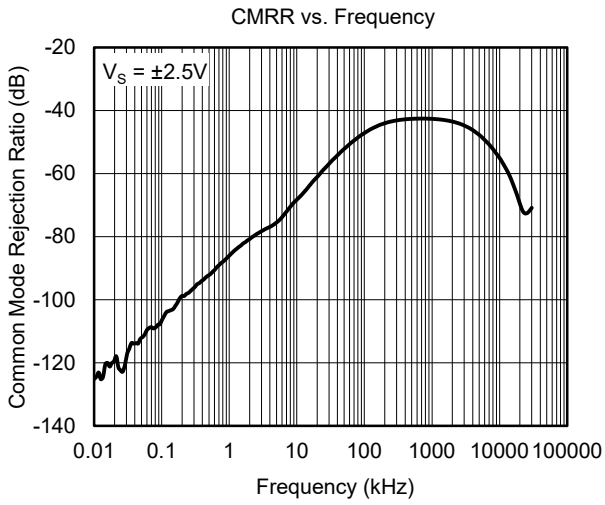



**REVISION HISTORY**

NOTE: Page numbers for previous revisions may differ from page numbers in the current version.

<b>DECEMBER 2023 – REV.A.4 to REV.B</b>	<b>Page</b>
Updated Absolute Maximum Ratings section.....	2
Updated Electrical Characteristics section .....	3, 4
Updated Typical Performance Characteristics section .....	6, 8
<b>JANUARY 2013 – REV.A.3 to REV.A.4</b>	<b>Page</b>
Added Tape and Reel Information section .....	12, 13
<b>DECEMBER 2011 – REV.A.2 to REV.A.3</b>	<b>Page</b>
Changed Electrical Characteristics section .....	3, 4
Changed Typical Performance Characteristics section .....	7
Changed Package Outline Dimensions section .....	9, 10
<b>MAY 2011 – REV.A.1 to REV.A.2</b>	<b>Page</b>
Changed packages' name .....	All
<b>APRIL 2010 – REV.A to REV.A.1</b>	<b>Page</b>
Changed Typical Performance Characteristics section .....	8
<b>Changes from Original (MARCH 2010) to REV.A</b>	<b>Page</b>
Changed from product preview to production data.....	All

PACKAGE OUTLINE DIMENSIONS

SOIC-8

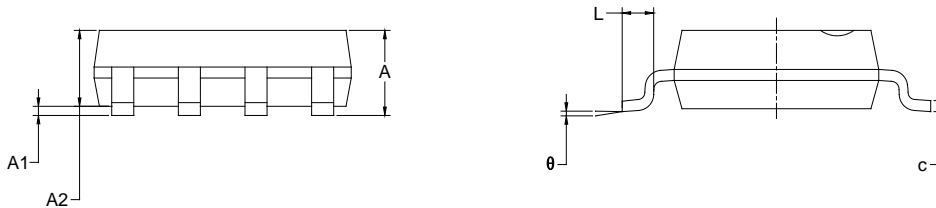
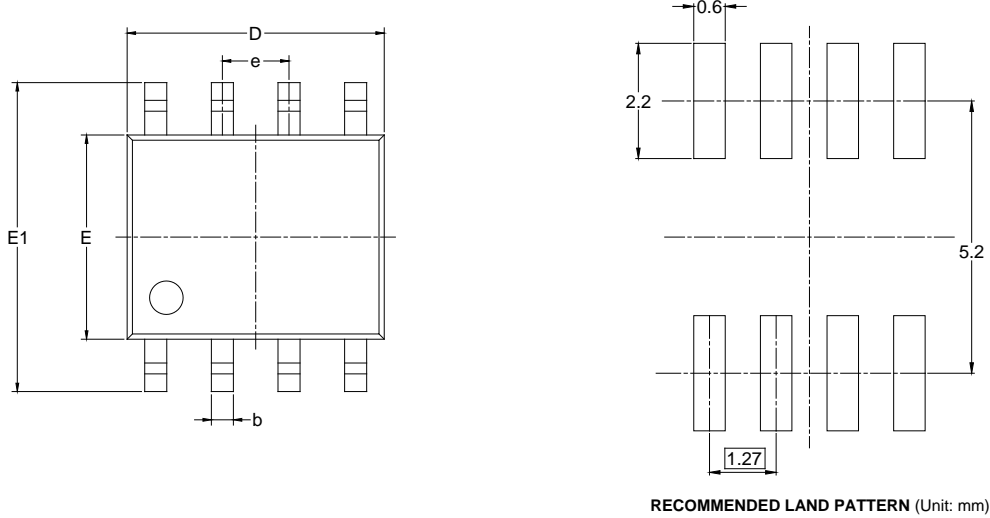

Symbol	Dimensions In Millimeters		Dimensions In Inches	
	MIN	MAX	MIN	MAX
A	1.350	1.750	0.053	0.069
A1	0.100	0.250	0.004	0.010
A2	1.350	1.550	0.053	0.061
b	0.330	0.510	0.013	0.020
c	0.170	0.250	0.006	0.010
D	4.700	5.100	0.185	0.200
E	3.800	4.000	0.150	0.157
E1	5.800	6.200	0.228	0.244
e	1.27 BSC		0.050 BSC	
L	0.400	1.270	0.016	0.050
θ	0°	8°	0°	8°

NOTES:  
 1. Body dimensions do not include mode flash or protrusion.  
 2. This drawing is subject to change without notice.

PACKAGE OUTLINE DIMENSIONS

MSOP-8

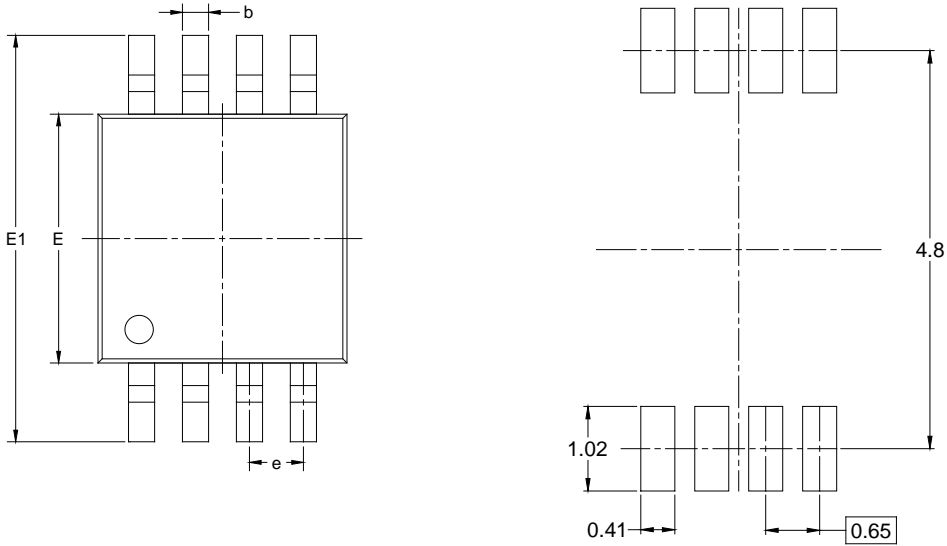

RECOMMENDED LAND PATTERN (Unit: mm)

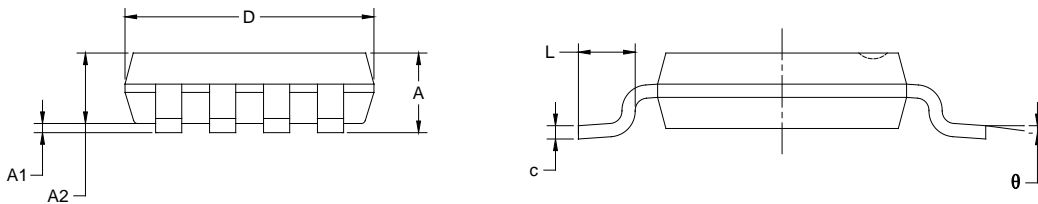

Symbol	Dimensions In Millimeters		Dimensions In Inches	
	MIN	MAX	MIN	MAX
A	0.820	1.100	0.032	0.043
A1	0.020	0.150	0.001	0.006
A2	0.750	0.950	0.030	0.037
b	0.250	0.380	0.010	0.015
c	0.090	0.230	0.004	0.009
D	2.900	3.100	0.114	0.122
E	2.900	3.100	0.114	0.122
E1	4.750	5.050	0.187	0.199
e	0.650 BSC		0.026 BSC	
L	0.400	0.800	0.016	0.031
θ	0°	6°	0°	6°

NOTES:

1. Body dimensions do not include mode flash or protrusion.
2. This drawing is subject to change without notice.

## TAPE AND REEL INFORMATION

### REEL DIMENSIONS



### TAPE DIMENSIONS



NOTE: The picture is only for reference. Please make the object as the standard.

### KEY PARAMETER LIST OF TAPE AND REEL

Package Type	Reel Diameter	Reel Width W1 (mm)	A0 (mm)	B0 (mm)	K0 (mm)	P0 (mm)	P1 (mm)	P2 (mm)	W (mm)	Pin1 Quadrant
SOIC-8	13"	12.4	6.40	5.40	2.10	4.0	8.0	2.0	12.0	Q1
MSOP-8	13"	12.4	5.20	3.30	1.50	4.0	8.0	2.0	12.0	Q1

DD0001

# PACKAGE INFORMATION

## CARTON BOX DIMENSIONS



NOTE: The picture is only for reference. Please make the object as the standard.

## KEY PARAMETER LIST OF CARTON BOX

Reel Type	Length (mm)	Width (mm)	Height (mm)	Pizza/Carton
13"	386	280	370	5

DD0002